

Refrigerated Fish Display with compressor PS GN 089KT (BMVI.FG089B.00)



SKU: PS GN 089KT

Dimensions: 89 × 70 × 130 cm

Weight: 96 Kg

Recomended industries: SEAFOOD

Higher Temperature (C): +5

Lower Temperature (C): -1

Volume (m3): 0.81

Capacity: 195

Horse Power (HP): 1/4

Doors: 2

Product Description

All refrigerators have insulation polyurethane, 1 shelf per door, magnetic sealing rubbers (Easy to change) and electronic thermostat with automatic defrost.

Product Photos

Technical Drawing

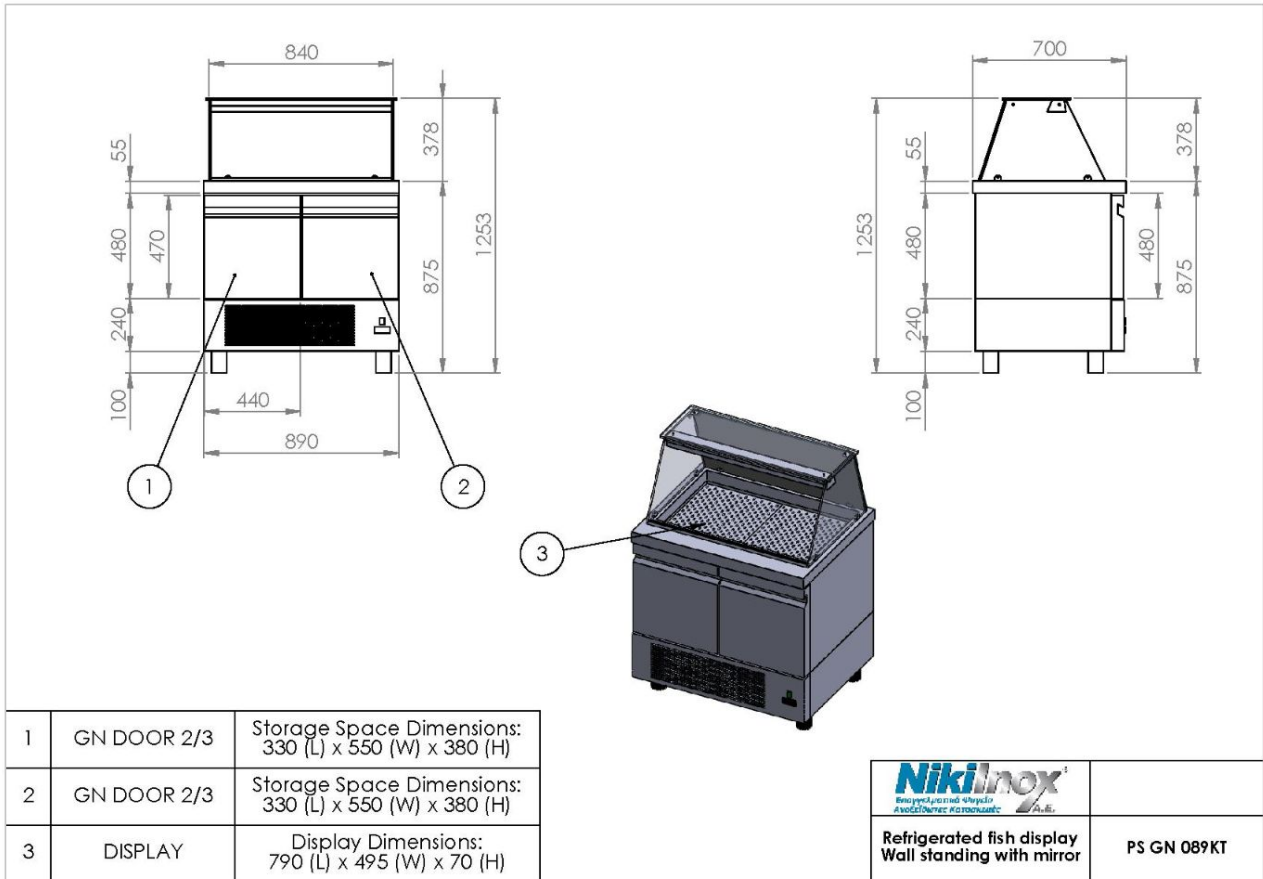

NIKI INOX S.A.

Industrial Area of Thessaloniki
 P.O. Box 1056, 57022 Sindos
 VAT: 082104633 G.E.MI. No:
 38081805000

T: +30 2310 798 696
 F: +30 2310 797 920
 URL: <https://niki-inox.gr>
 E: info@niki-inox.gr