

Heated Display with airflow THE 80 089A



SKU: THE 80 089A

Dimensions: 89 × 80 × 129 cm

Weight: 88 Kg

Recommended industries: GENERAL USE

Volume (m3): 0.87

Power consumption (W): 1600

Doors: 3

Product Description

All refrigerators have insulation polyurethane, 1 shelf per door, magnetic sealing rubbers (Easy to change) and electronic thermostat with automatic defrost.

Product Photos

Technical Drawing

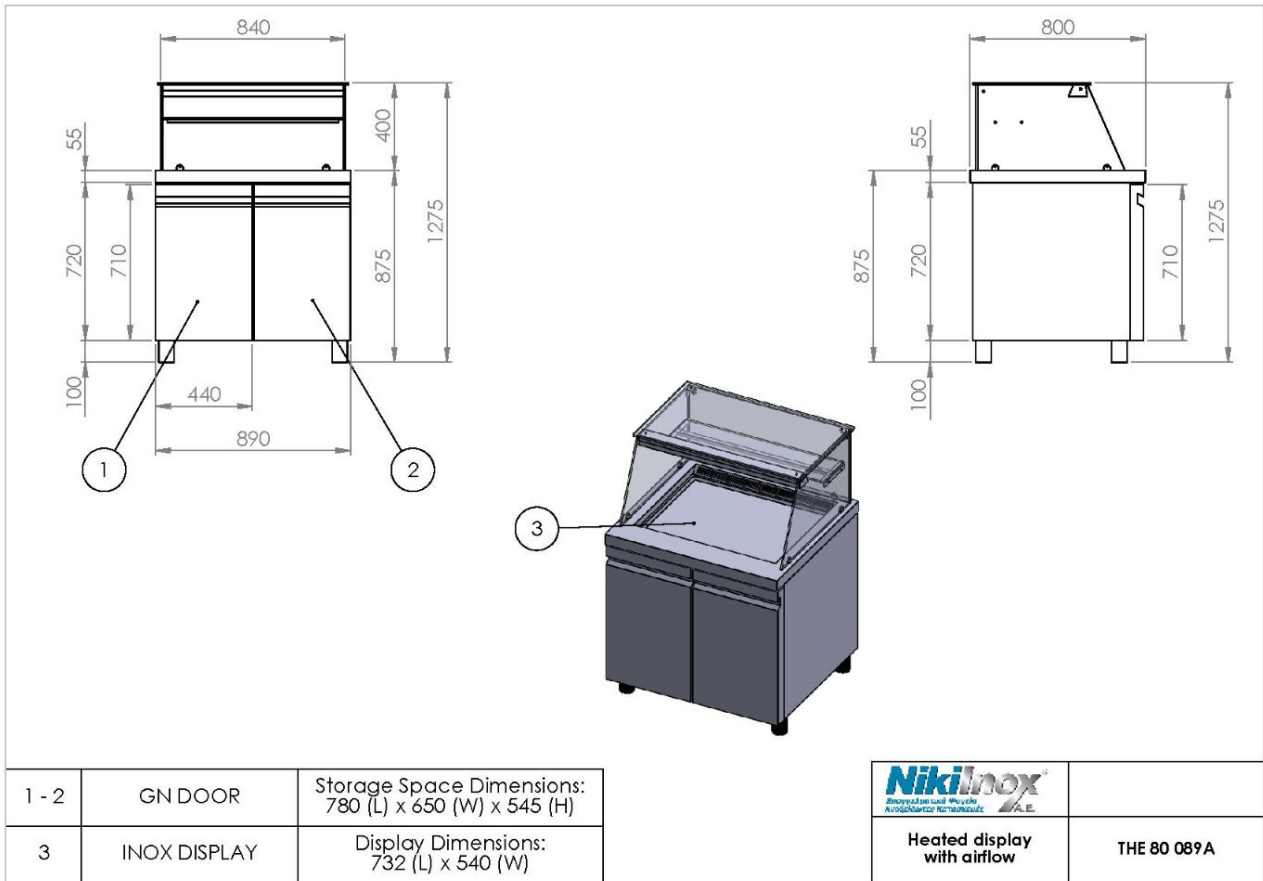

NIKI INOX S.A.

Industrial Area of Thessaloniki
 P.O. Box 1056, 57022 Sindos
 VAT: 082104633 G.E.MI. No:
 38081805000

T: +30 2310 798 696
 F: +30 2310 797 920
 URL: <https://niki-inox.gr>
 E: info@niki-inox.gr