

## Refrigerated Salad Display with compressor SA GN 179M (R0S7.GN179R)



**SKU: SA GN 179M**

**Dimensions:** 179 × 70 × 129 cm

**Weight:** 147 Kg

### Product Description

All refrigerators have insulation polyurethane, 1 shelf per door, magnetic sealing rubbers (Easy to change) and electronic thermostat with automatic defrost.

### Product Photos

### Technical Drawing

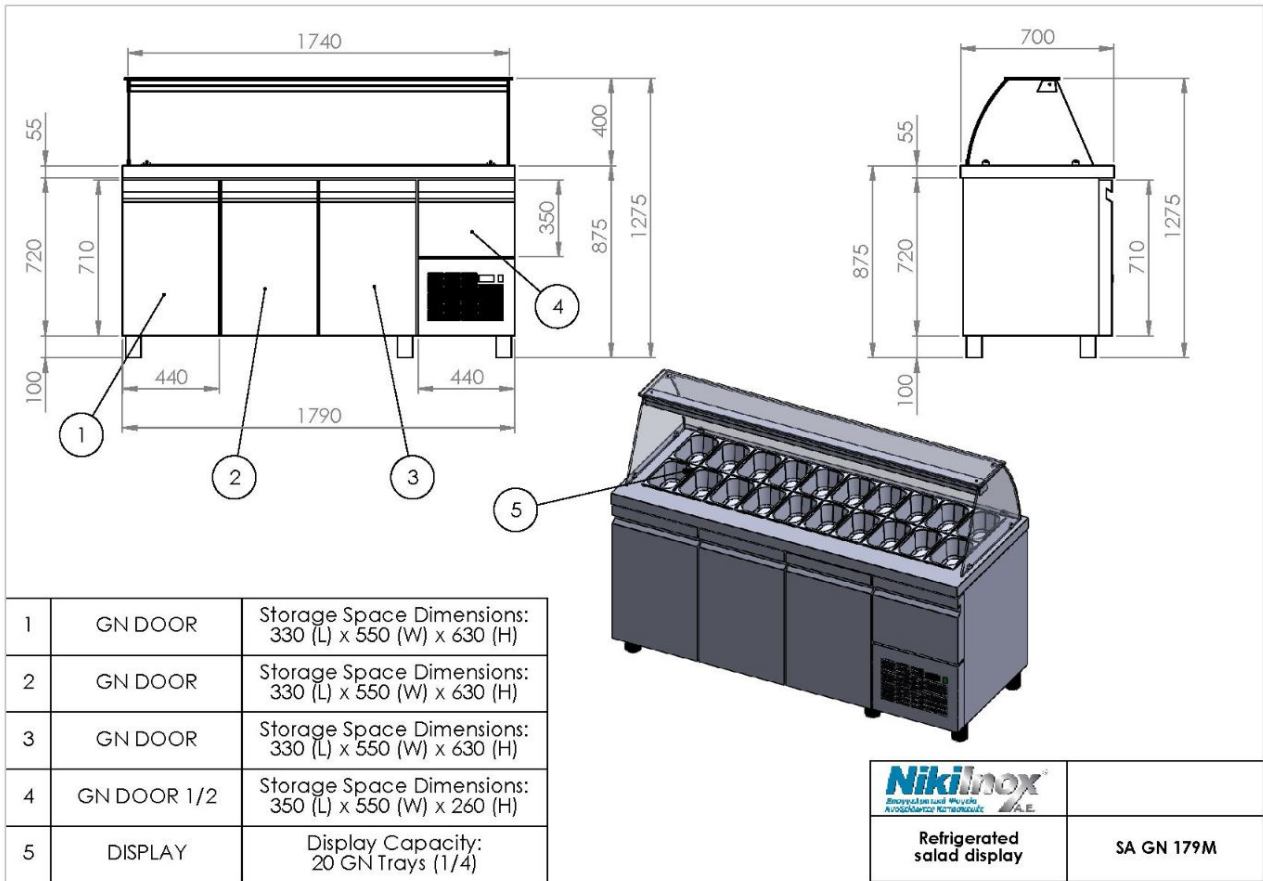

**NIKI INOX S.A.**

Industrial Area of Thessaloniki  
 P.O. Box 1056, 57022 Sindos  
 VAT: 082104633 G.E.MI. No:  
 38081805000

T: +30 2310 798 696

F: +30 2310 797 920

URL: <https://niki-inox.gr>

E: [info@niki-inox.gr](mailto:info@niki-inox.gr)

