

Refrigerated Counter without compressor PA GN 105A (R0PA.GN105A.00)



SKU: PA GN 105A

Dimensions: 105 × 70 × 88 cm

Weight: 94 Kg

Recomended industries: GENERAL USE

Volume (m3): 0.63

Capacity: 287

Doors: 2

Product Description

All refrigerators have insulation polyurethane, 1 shelf per door, magnetic sealing rubbers (Easy to change), switch cabinet and electronic thermostat.

Product Photos

Technical Drawing

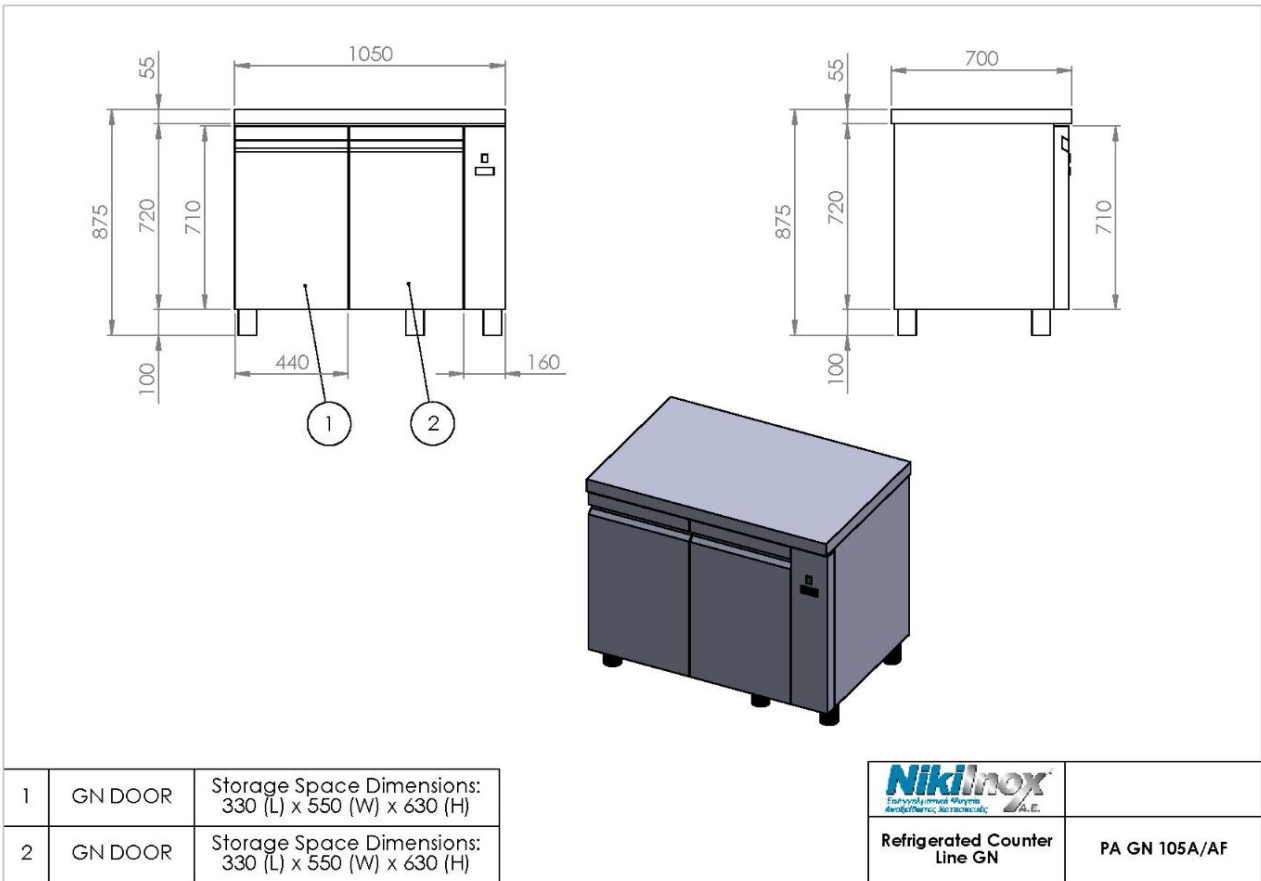

NIKI INOX S.A.

Industrial Area of Thessaloniki

P.O. Box 1056, 57022 Sindos

VAT: 082104633 G.E.MI. No:

38081805000

T: +30 2310 798 696

F: +30 2310 797 920

URL: <https://niki-inox.gr>

E: info@niki-inox.gr